

XIBU

DISINFECT / DISINFECT GEL / FOAM /
SEAT DISINFECT / CARE MOUSSE / FLUID hybrid

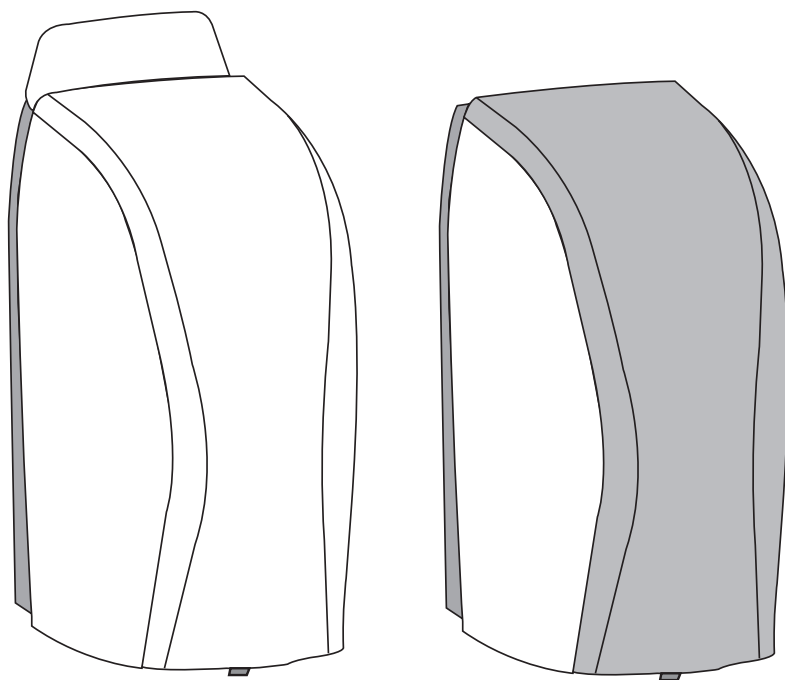

Xibu DISINFECT hybrid

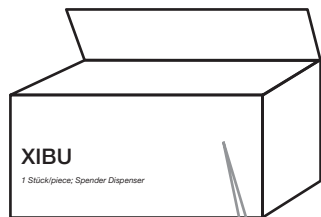

40°C
10°C

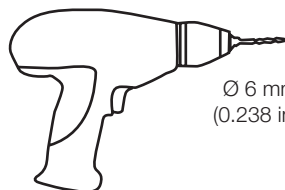
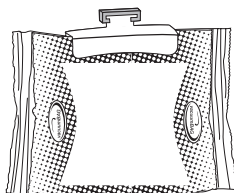

Ø 6 mm
(0.238 in)

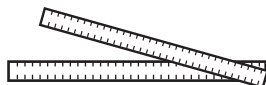

Option

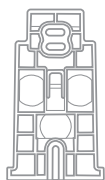
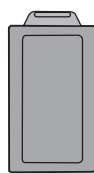
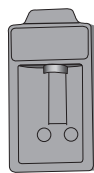
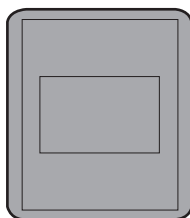

1 x



1 x



2 x



2 x



2 x

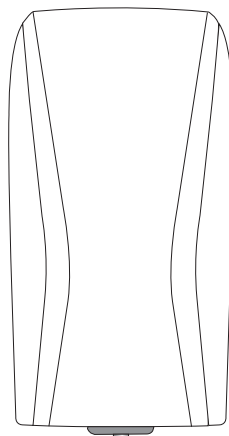

Xibu FOAM / SEAT DISINFECT / FLUID / CARE MOUSSE hybrid

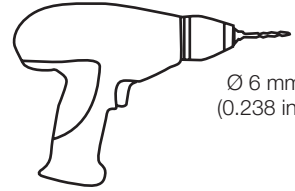
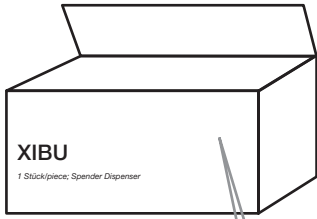

Ø 6 mm
(0.238 in)

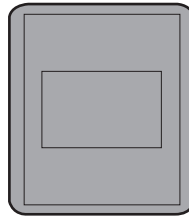
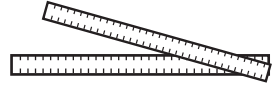
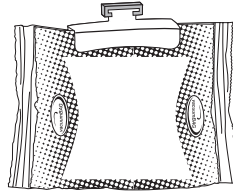

Option

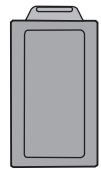
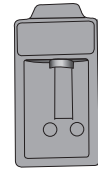

1 x



2 x



2 x



1 x



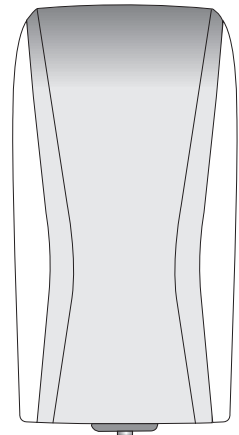

2 x



FOR THE UNITED STATES ONLY

General Safety Information

The following symbols and headings are used throughout this manual to indicate possible hazards to persons or equipment. The symbols and headings are shown in order of importance. For efficient and safe operation, be sure to follow the installation and operating instructions provided in this manual. In particular, all safety symbols and notices must be followed.

 WARNING	Indicates a potentially hazardous situation which, if not avoided, could result in serious injury or death.
 CAUTION	Indicates a potentially hazardous situation which, if not avoided, could result in minor personal injury.
NOTICE	This safety warning indicates possible hazards to the product or to other equipment.
IMPORTANT	Vital information or tips for the installer or operator.

General Safety Instructions

 CAUTION	<p>When installing any equipment, ensure that all national and local safety, electrical and plumbing codes are met.</p> <p>When using electrical appliances, basic safety precautions should always be followed.</p> <p>Always wear safety goggles to protect your eyes and wear other appropriate safety items for protection to avoid injury when drilling.</p>
---	--

IMPORTANT

- Do not mix old and new energy Boxes. Always remove exhausted batteries and dispose safely.
 - Americans with Disabilities Act: Title III of the Americans with Disabilities Act (ADA) governs, in detail, the placement and operation of dispensers. You should ensure that your mounting and use of dispensers complies with that law as well as the regulations issued under that statute. The mounting suggestions in this document may or may not fulfill the obligations of the ADA with respect to your facility.
 - For XIBU hybrid dispensers only: You should ensure that your mounting and use of the XIBU hybrid dispenser complies with national or local fire code safety regulations.
-

Xibu DISINFECT / DISINFECT GEL / FOAM / FLUID hybrid

1.



NOTICE

Do not install the dispenser above a mirrored surface and maintain the minimum installation dimensions in order to prevent unnecessary activation of the dispenser

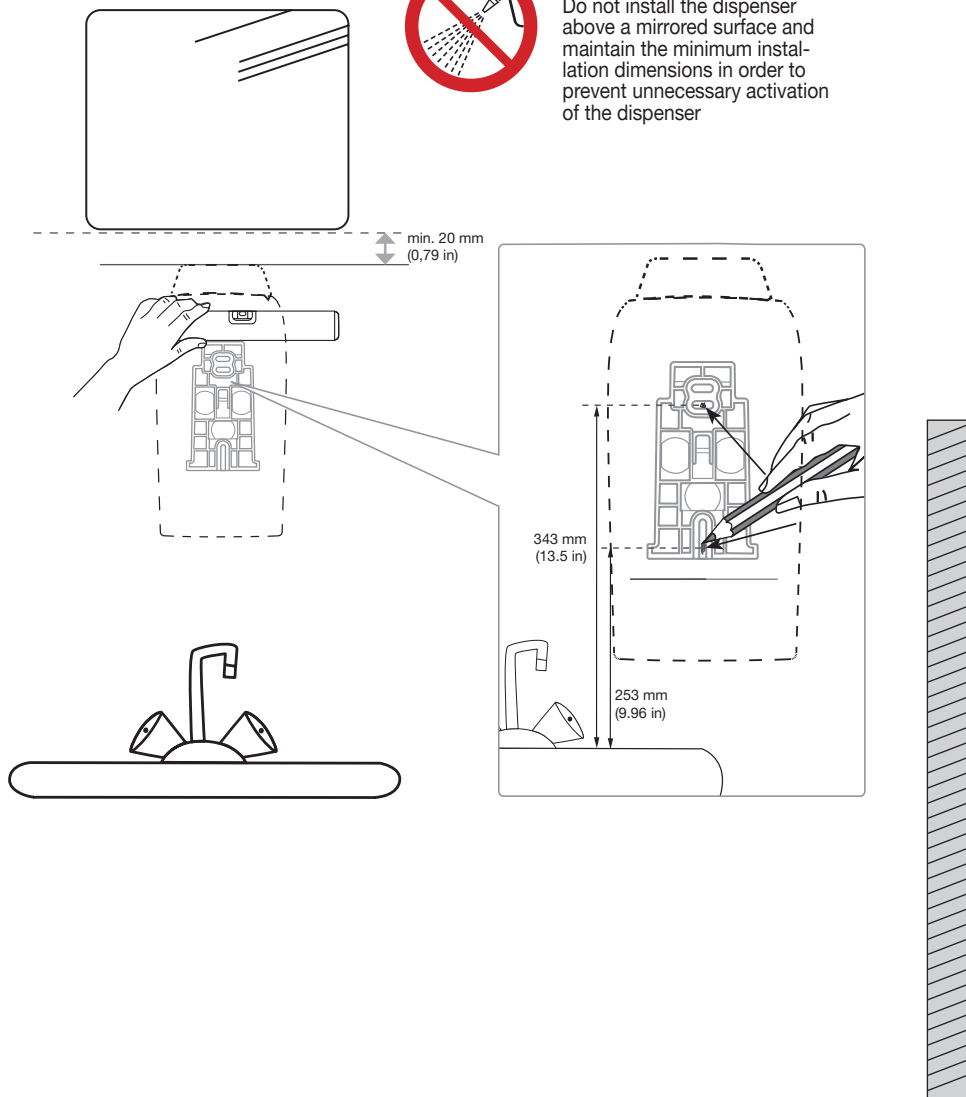

Xibu SEAT DISINFECT / CARE MOUSSE hybrid

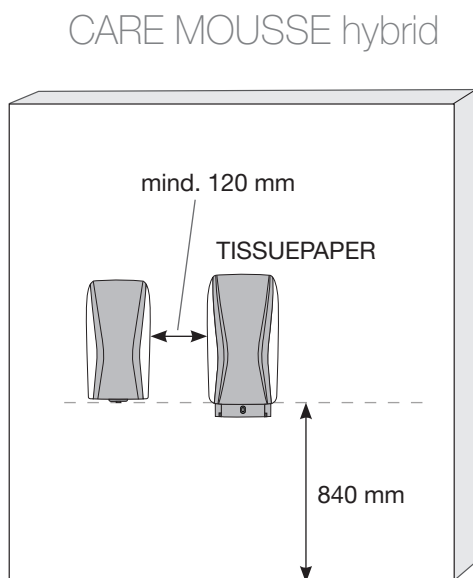
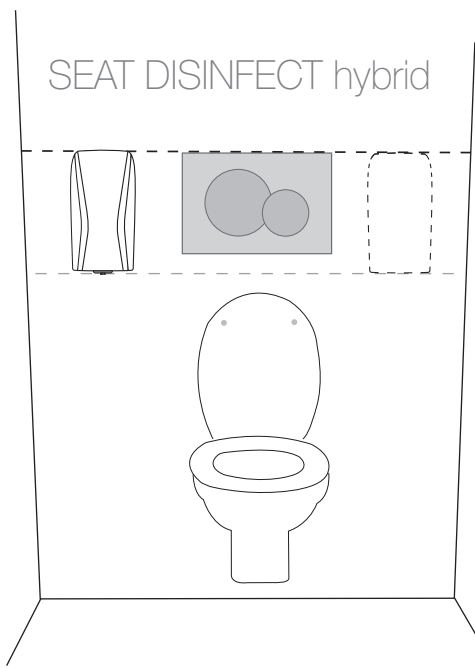
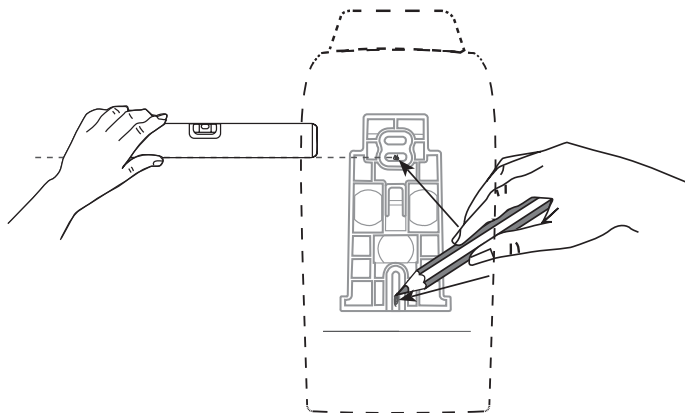



2. 2 x 

CAUTION

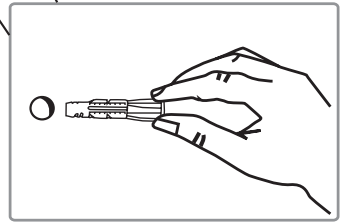
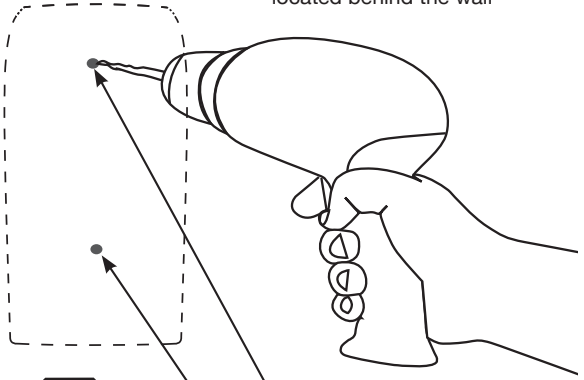
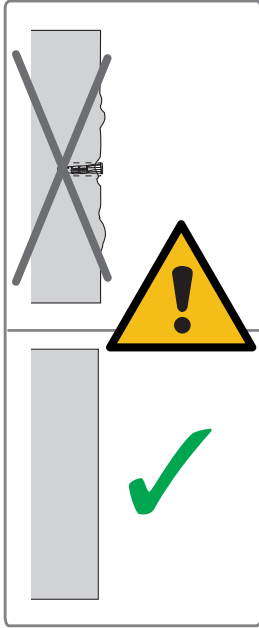
Before drilling the holes, make sure there are no pipes or wires located behind the wall

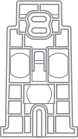

3. 1 x  2 x  2 x 

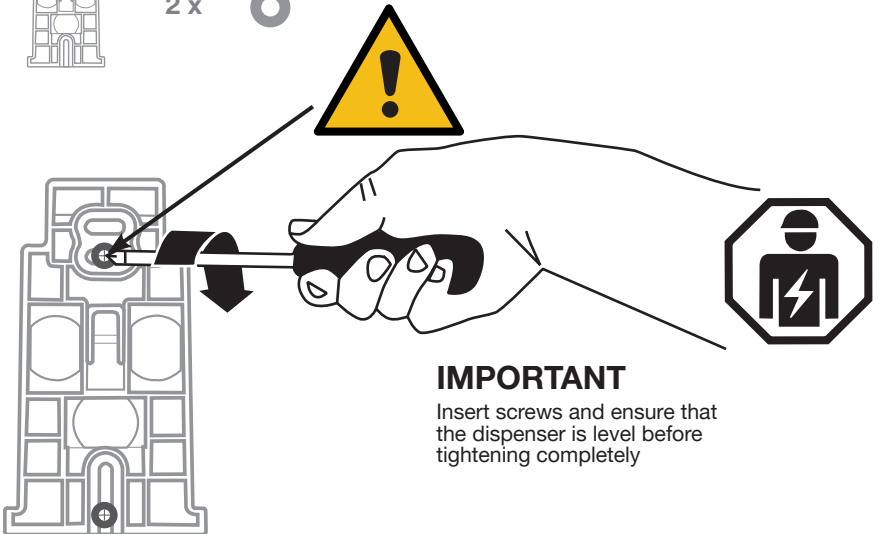

IMPORTANT

Insert screws and ensure that the dispenser is level before tightening completely

4.

1 x

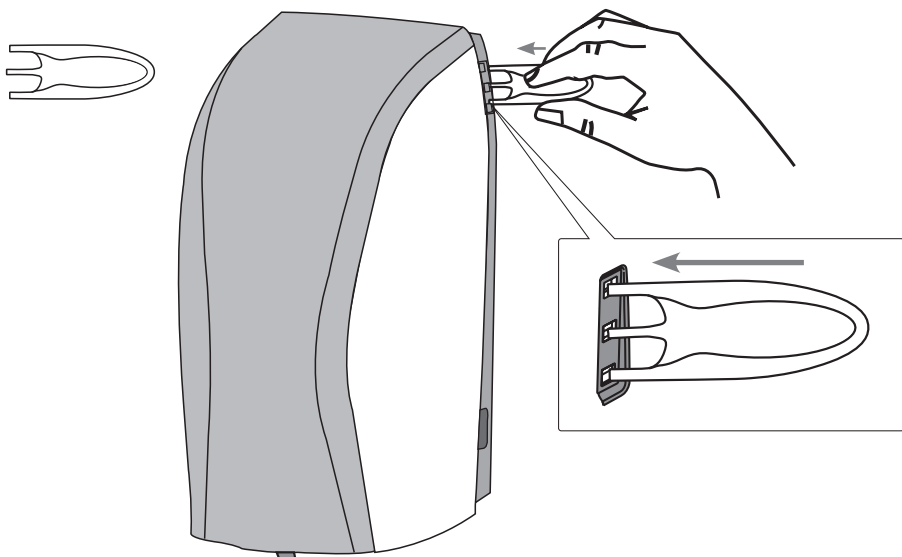

5.

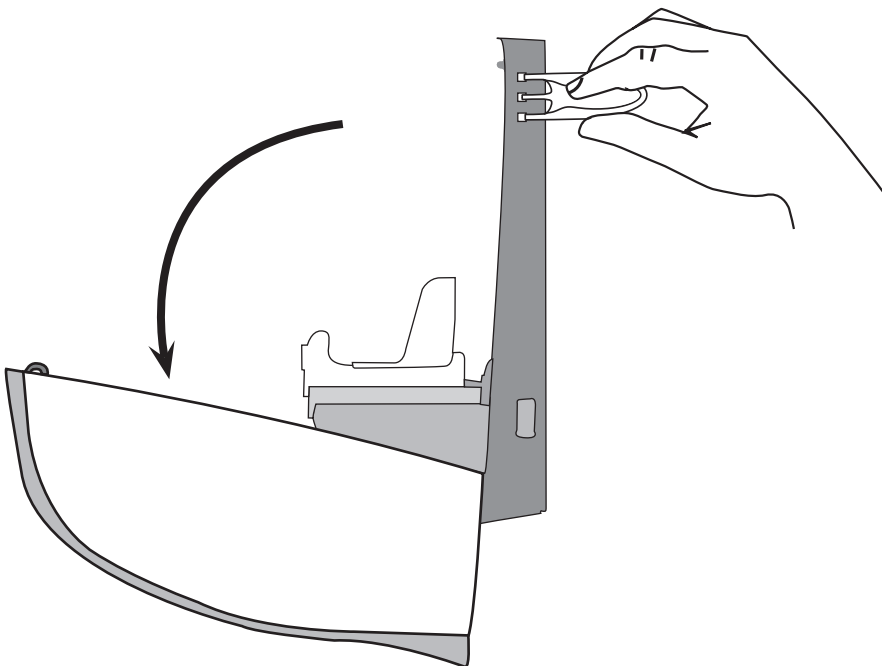

Option
XIBU CAP

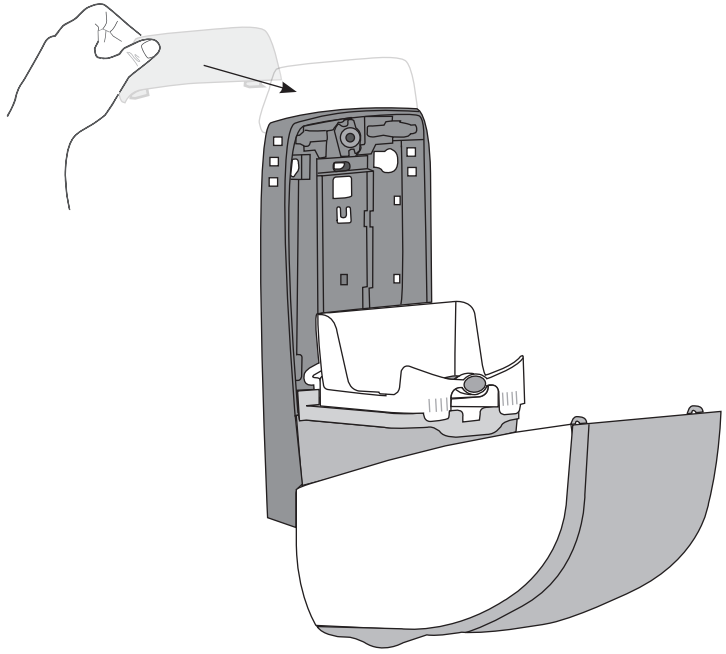

6.

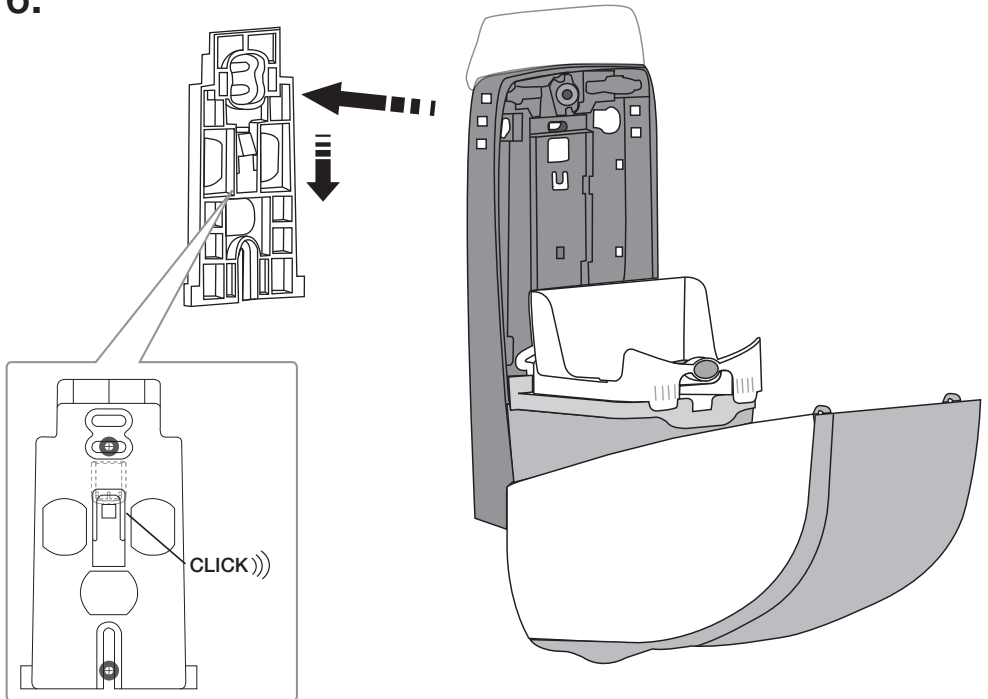

7.

energyBOX M

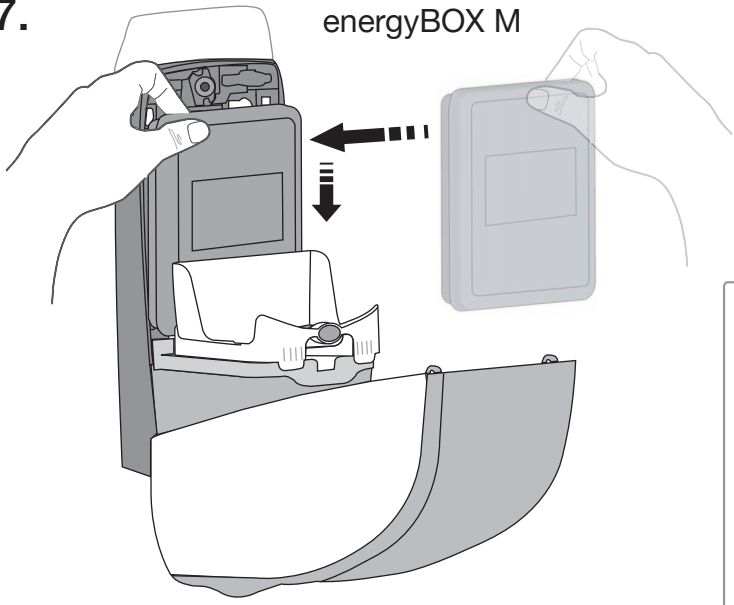

Option

rechargePOWER hybrid

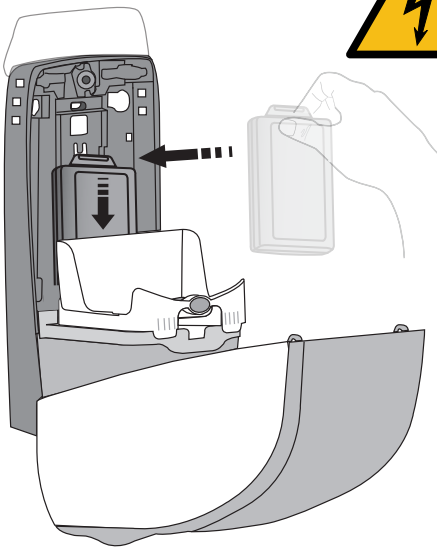
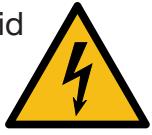

powerPACK ADAPTER hybrid

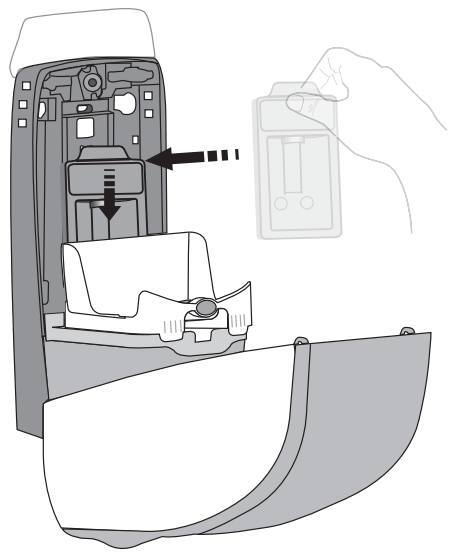

Please follow this link for further instructions:
https://cdn.hagleitner.com/fileadmin/user_upload/banleitung/20200622_BAL_powerSTATION_recharge.pdf

Please follow this link for further instructions:
https://cdn.hagleitner.com/fileadmin/user_upload/banleitung/20200622_BAL_powerPACK_ex_in_hybrid.pdf

8.

1 x



⚠ CAUTION

Please verify that the correct product is used

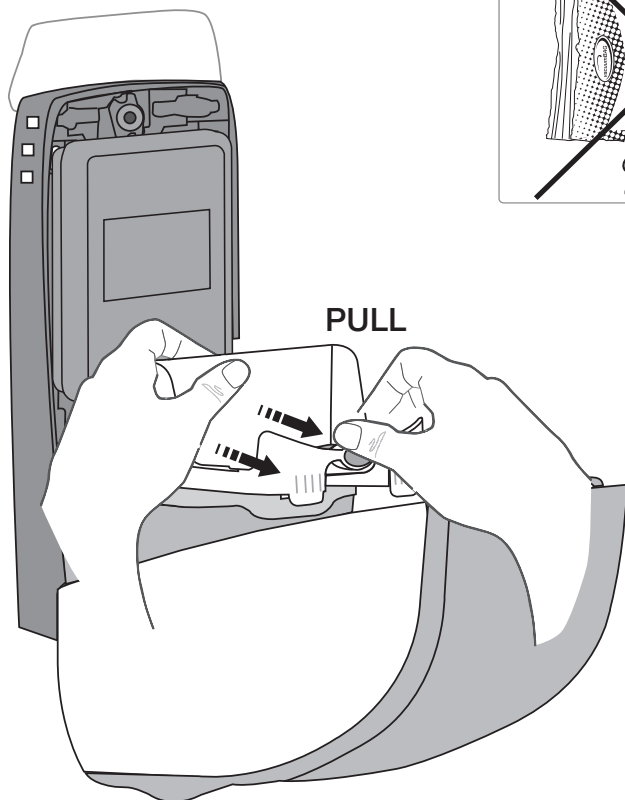
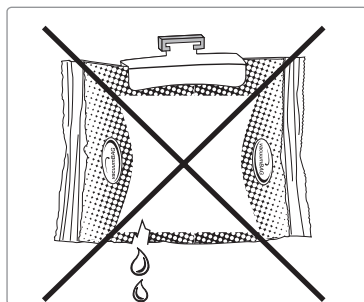
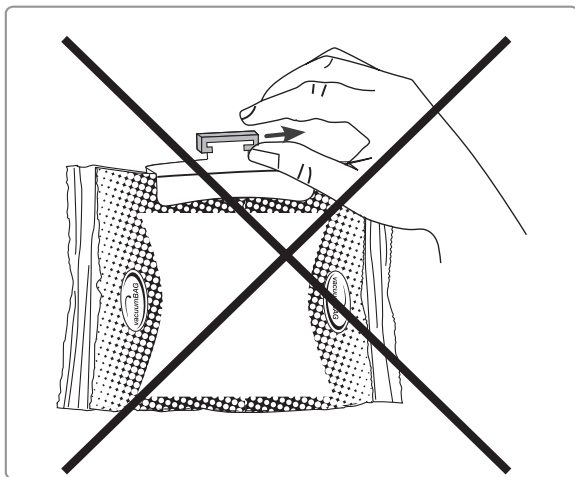

9.

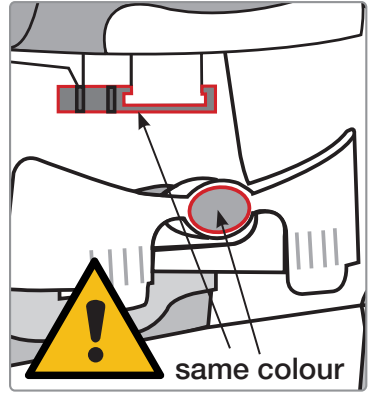
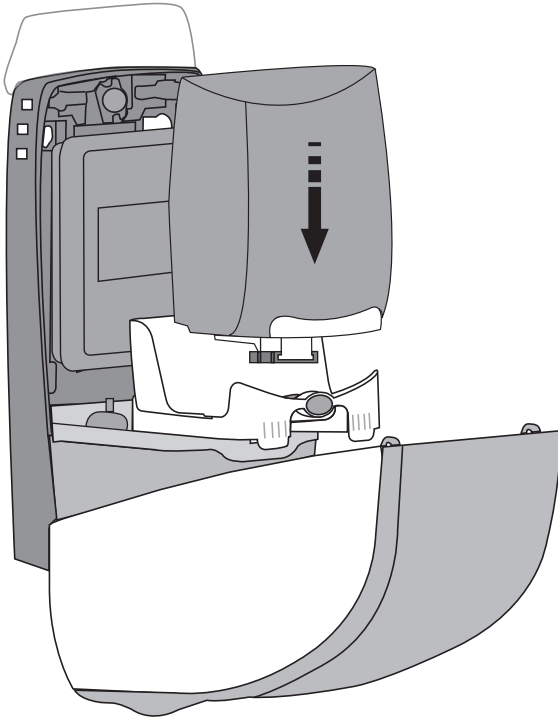

10.

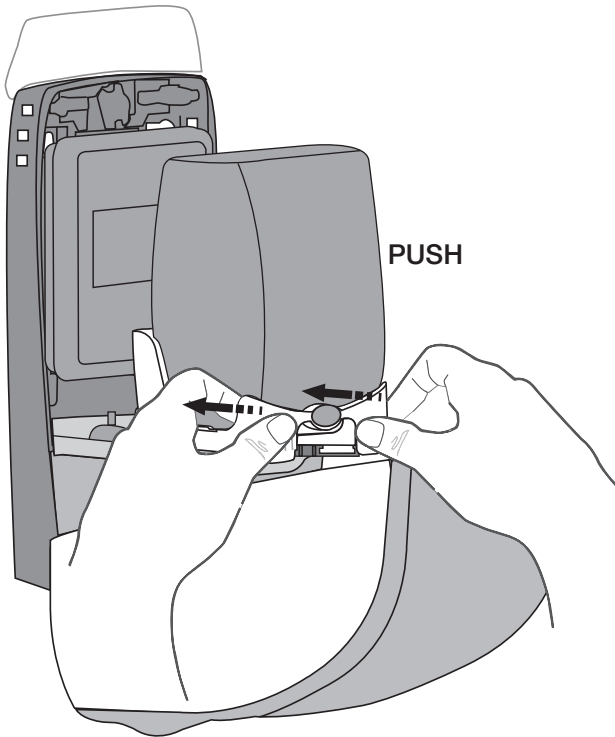

11.

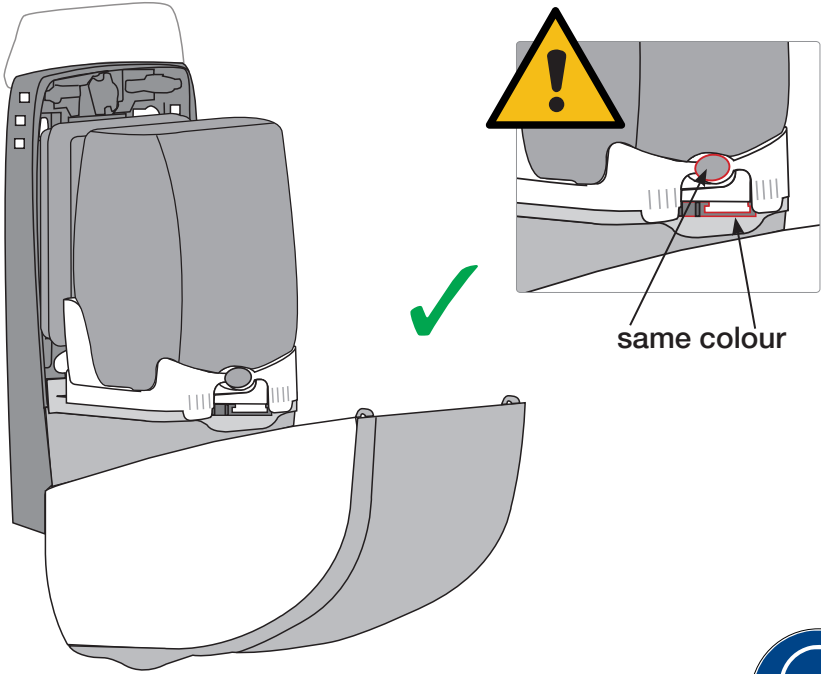

12.

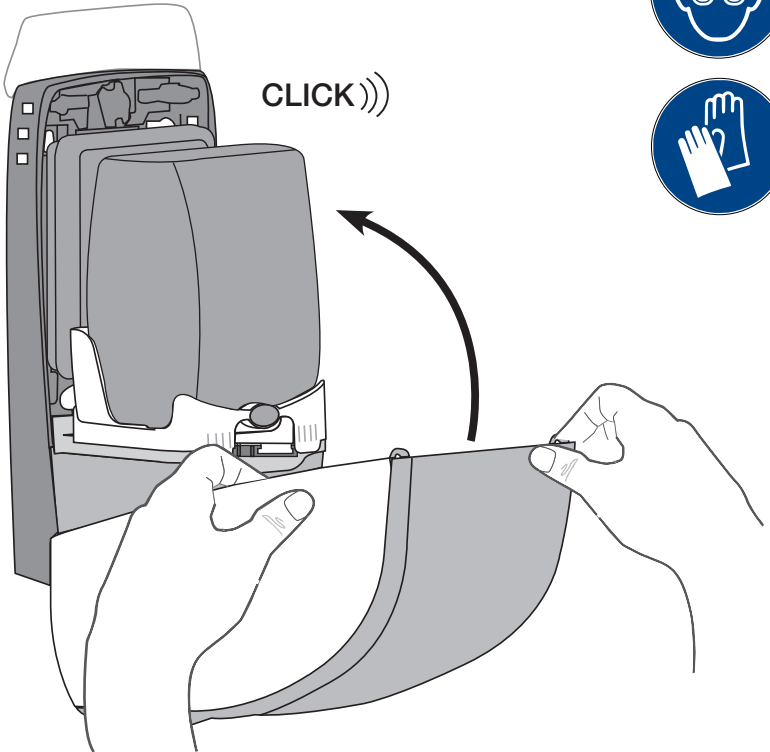

13.

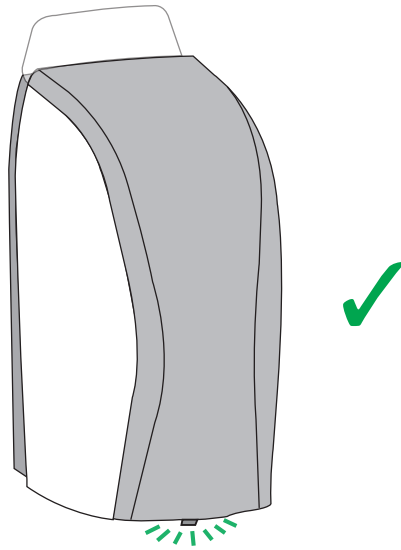

14.

DISINFECT /
DISINFECT GEL /
FLUID hybrid

FOAM hybrid

SEAT DISINFECT /
CARE MOUSSE hybrid

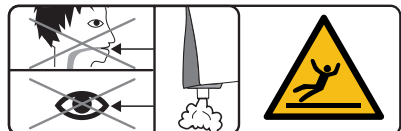
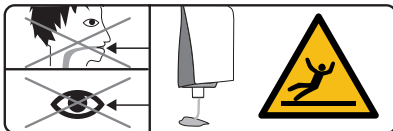
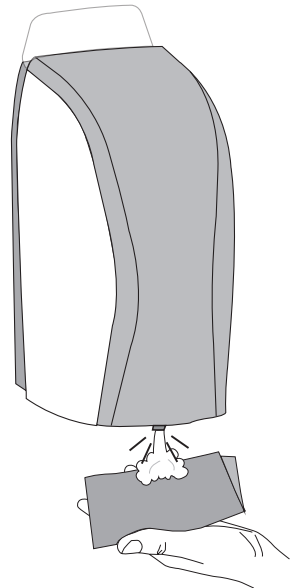
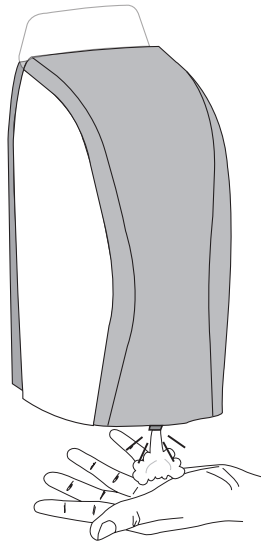
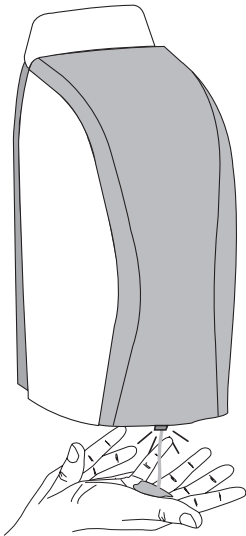

15.

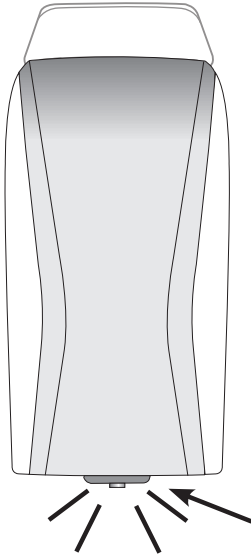

green	= ok		
green+red	= change		
red	=		
... + blue	=		
no signal	= change		

WICHTIG / IMPORTANT

Nutzerregistrierung für Verbrauchseinstellungen
und Datenverfügbarkeit:

Aktivierung erforderlich!

User registration for consumption settings and data availability:

Activation required!



